

FLEET™ SERIES

PRODUCT INSTRUCTIONS STATIC MODEL

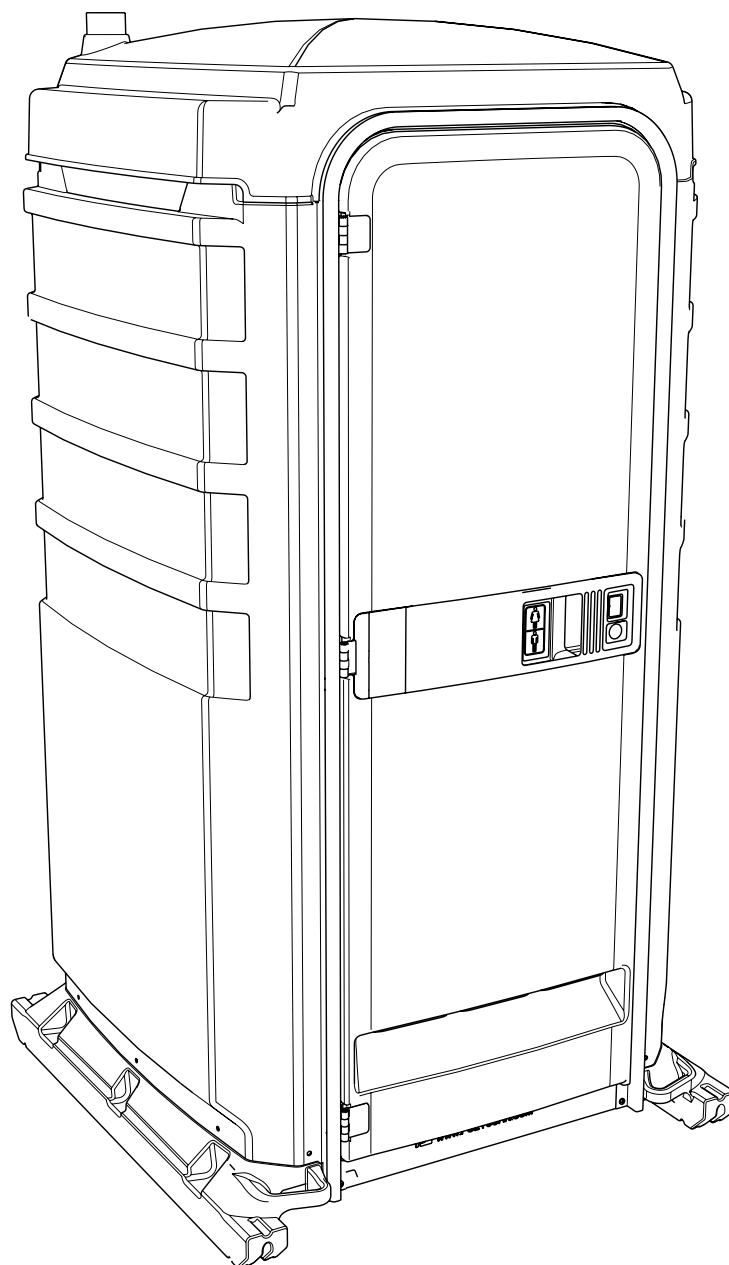

POLYJOHN®
there when you need us



NOTE: We recommend reading through the entire Assembly Instructions prior to proceeding with installation, service or maintenance. All references to left and right throughout this guide are as viewed from the front.

PRODUCT SPECIFICATIONS

MODEL NO: FS3-1000

FLEET™ SERIES
STATIC

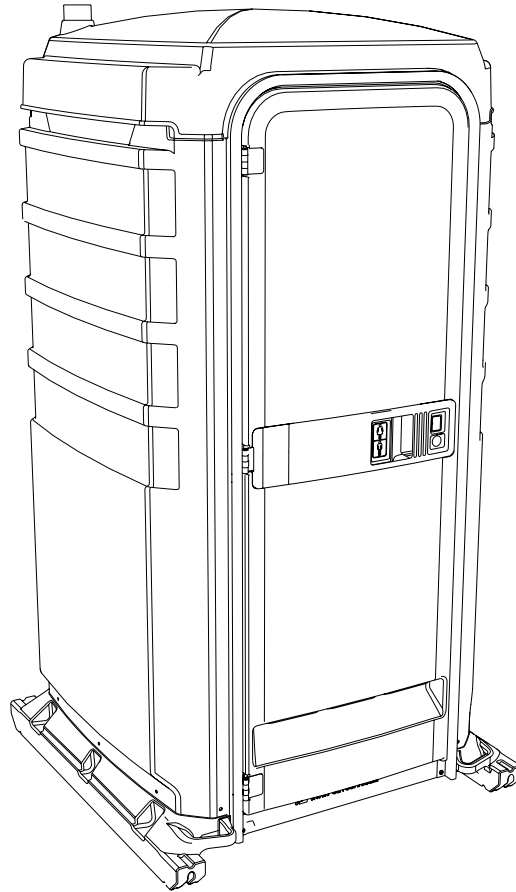

DIMENSION	IMPERIAL	METRIC
Exterior Height	91 in	231 cm
Interior Height	83 in	211 cm
Exterior Width	47 in	119 cm
Interior Width	45.7 in	116 cm
Exterior Length (Runner Base)	48 in	122 cm
Exterior Length (Optional Signature Style Handle Base)	47 in	119 cm
Interior Length	43 in	109 cm
Weight	195 lb.	88 kg
Door Frame Height (ID)	75 in	191 cm
Door Frame Width (ID)	26 in	66 cm
Side Panel Decal Area	6 in X 37 in	15 cm X 94 cm
Door Decal Area	22.5 in X 29 in	57 cm X 74 cm
Seat Height	19.5 in	49.5 cm

PRODUCT OVERVIEW

FLEET™ SERIES
STATIC

- These instructions are for restrooms shipped unassembled. Please retain these instructions for maintenance and repair purposes.
 - The FS3-1000 Model restroom assembly will require two people.
 - All references to left, right, front and rear are as viewed from the front of the restroom.
 - Review the entire instruction manual prior to assembly.
 - Please follow the instructions in the order they are presented.
 - When using air operated screw drivers or impact wrenches, be sure that the torque setting does not exceed 28 inch pounds.
Also, when using a batteryoperated drill, set it to the lowest torque setting.
 - We strongly suggest that these restrooms, as with all portable structures, be transported and handled with care. Dropping the restroom when loading and unloading could cause damage to the door jamb and other components.
-

TOOLS REQUIRED FOR ASSEMBLY



Rivet Gun

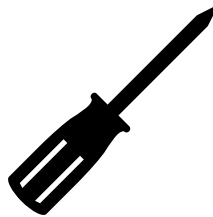

Standard Slotted
Screwdriver

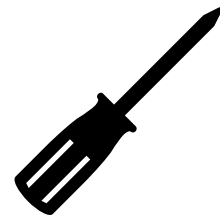

Phillips Crosshead
Screwdriver



Drill with 13/64"
Drill Bit

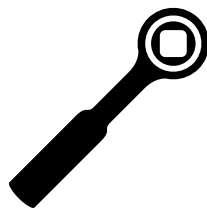

Socket Wrench
with a 7/16" socket

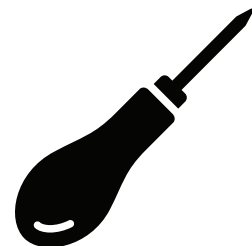

(2) Tapered Awls

FULL SIZE SCALE FASTENER DRAWINGS

FLEET™ SERIES
STATIC

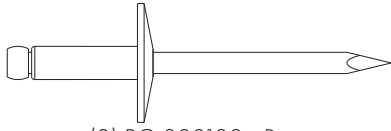

(8) PC-000100 - Rivet

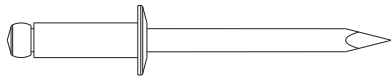

(9) PC-000102 - RIVET

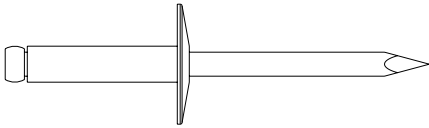

(6) PC-000103 - RIVET

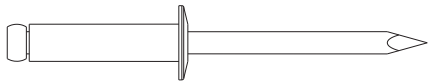

(42) PC-000104 - RIVET

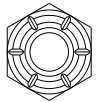

(4) PC-000140 LOCK NUT



(31) PC-000106 - Washer

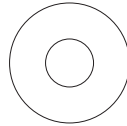

(4) PC-000123 - Washer

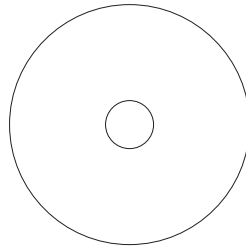

(4) PC-000121 - Washer

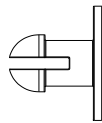

(4) PC-000367 - NYLON
PUSH-IN FASTENER

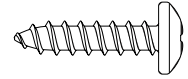

(2) PC-000147
3/4" PHILLIPS SELF
TAPPING SCREW

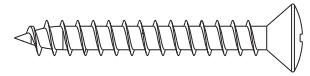

(5) PC-000158
1-1/2" PHILLIPS SELF
TAPPING SCREW

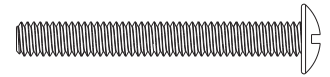

(6) PC-000231
10-32 X 1-1/2" SCREW

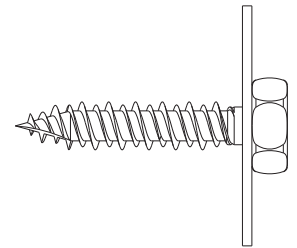

(14) PC-000192 SEMS

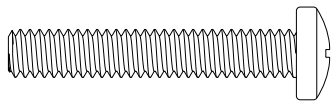

(2) PC-000175 - SCREW

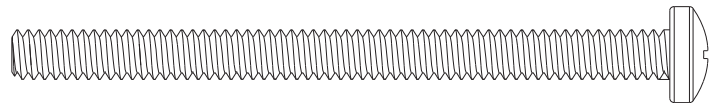

(2) PC-000159 - SCREW

ASSEMBLY INSTRUCTIONS

FLEET™ SERIES
STATIC

STEP 1:

SIDEWALL PANELS TO REAR EXTRUSIONS AND REAR WALL PANEL

Slide a plastic rear extrusion onto each side of the rear panel making sure that the mitered ends are towards the top of the rear panel (where the fly screens are, and the ribbed side of the extrusions are facing toward the outside of the restroom). Line up the holes in the rear extrusions with the holes in the rear wall panels. Insert awls into the center holes. Slide the right side wall panel into the corresponding slot of the rear extrusion and remove the awl from that rear extrusion. Line up all of the holes and rivet from the inside, the rear extrusions, rear wall panel and side wall panel together using small flange rivets, PC-000104. **DO NOT RIVET THE TOP HOLE IN EITHER OF THE EXTRUSIONS AT THIS TIME.** Remove the awl in the left extrusion and rivet together the left side wall panel, left rear extrusion, and rear panel, leaving the top hole for later.

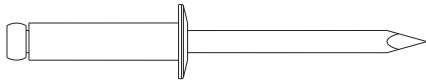

PC-000104 Rivet
(16) Used in this step



Figure 1

STEP 2:

SIDEWALL PANELS TO DOOR JAMB

Insert the edge of the left side panel into the slot on the left side of the door jamb. Line up the holes in the jamb with the corresponding holes in the side panel. Rivet the second and third holes from the bottom as well as the top two holes using (4) PC-000104 rivets (as shown on the right). Using holes in the jamb as a guide, drill three 13/64" holes into the side panel. Rivet the PC-000181 plastic cable clip at the center two holes of the jamb using (2) PC-000104 rivets. Rivet the bottom hole using the same rivet. Wrap the cabana around the base of the unit resting the bottom edge of the sides on the ledge around the base. Slide the edge of the right side wall panel into the slot in the jamb. Line up the holes in the side panel with the corresponding holes in the jamb and rivet in place using (4) PC-000104 rivets. **DO NOT RIVET THE SECOND HOLE FROM THE TOP AT THIS TIME.** Using a drill with a 13/64" drill bit, drill out the third hole from the top as well as the bottom hole. Rivet the bottom hole using a PC-000104 rivet. The PC-000223 grab handle gets attached to the jamb using (2) PC-000104 rivets at the second and third hole locations (as shown on the right).

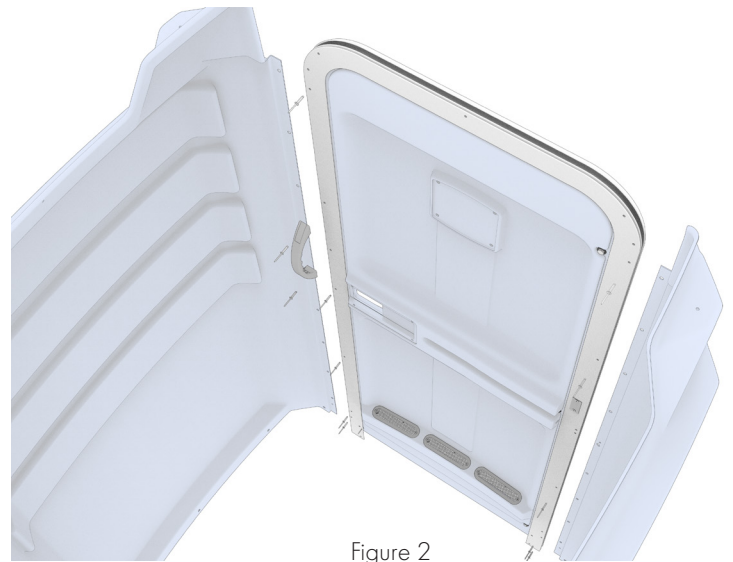
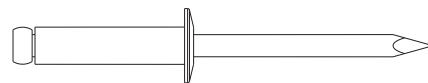

Figure 2



PC-000104 Rivet
(14) Used in this step

ASSEMBLY INSTRUCTIONS

FLEET™ SERIES
STATIC

STEP 3:

CABANA TO BASE

Insert (2) PC-000175 screws through the holes at the very bottom of the jamb, and (2) PC-000159 screws through the holes second from the bottom and into the slots in the base. On the back-side of the unit, center the rear panel on the base. Fasten the rear panel to the base using (4) PC-000192 sems. Gently lay the unit on it's back. Place (4) PC-000123 washers and (4) PC-000140 nuts on the PC-000159 and PC-000175 screws at the front of the base, but **DO NOT TIGHTEN AT THIS TIME**. Close the door and tighten the PC-000175 screws (making sure that there is a 1/4" gap between the latch side of the door and the jamb). Open the door and tighten the PC-000159 screws.

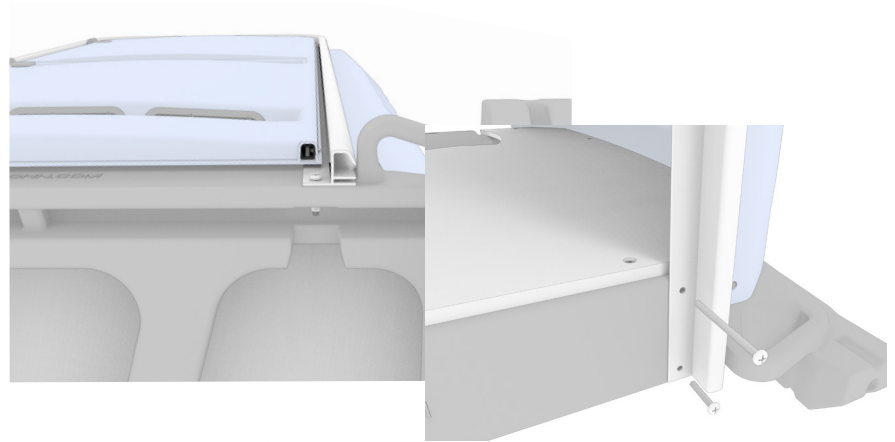
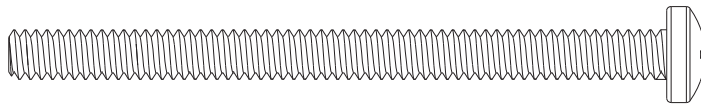
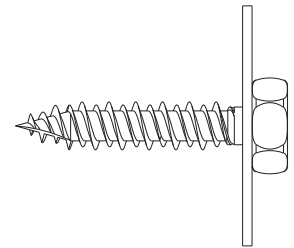

Figure 3



PC-000159 - SCREW
(2) Used in this step



PC-000192 SEMS
(4) Used in this step



PC-000140 LOCK NUT
(4) Used in this step

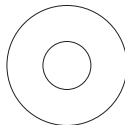

PC-000123 - WASHER
(4) Used in this step

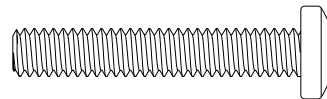

PC-000175 - SCREW
(2) Used in this step

STEP 4:

CABANA TO BASE

Carefully stand the unit upright. Starting with the left of the unit, drive a PC-000192 sems screw through the pre-drilled hole in the front of the side panel. **BE SURE NOT TO OVERTIGHTEN AND STRIP OUT THE PLASTIC.** Continue around the left side of the unit until you reach the rear extrusion. Repeat this process with the right side of the unit, starting with the front.

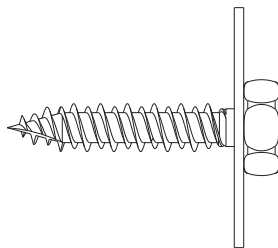

PC-000192 SEMS
(10) Used in this step

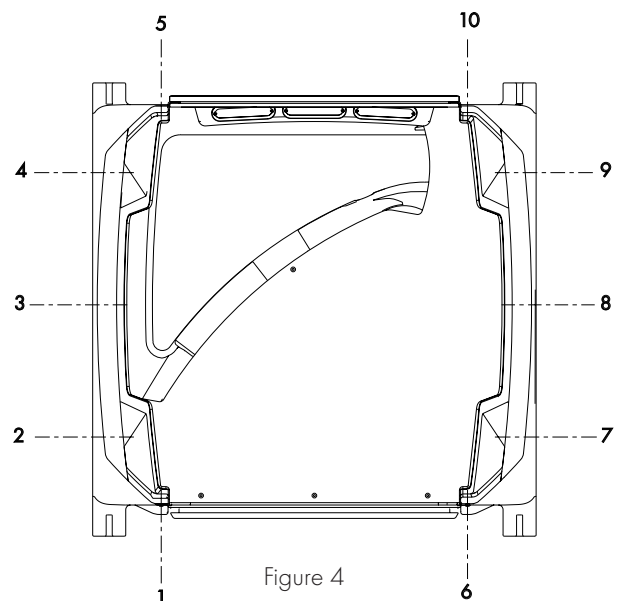

Figure 4

ASSEMBLY INSTRUCTIONS

FLEET™ SERIES
STATIC

STEP 5:

TANK INSTALLATION

On the inside of the unit, pull the tank forward in the opening of the floor. Locate dimples in the lower portion of the rear and left wall panels. Drill four 13/64" holes through the dimples and into the back of the tank. Rivet from outside the restroom using (4) PC-000103 rivets with (4) PC-000106 back-up washers on the inside of the tank.

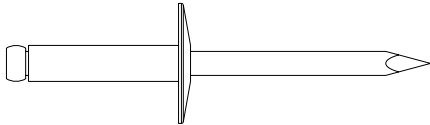

PC-000103 RIVET
(4) USED IN THIS STEP

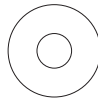

PC-000106 WASHER
(4) USED IN THIS STEP

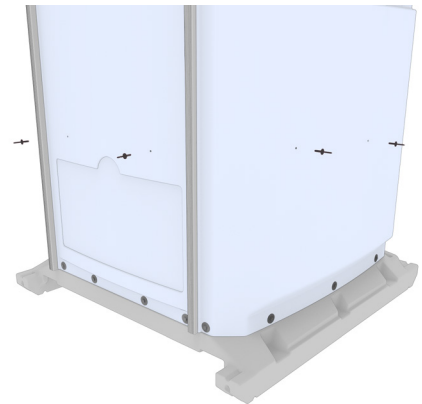
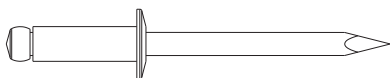

Figure 5

STEP 6:

SCREEN INSTALLATION

Take a SG1-0035 large fly screen and place the bottom curved flanges onto the top of the right side panel (as shown on the right.) Tilt the top of the fly screen up into place. Using the hole in the bottom, middle flange as a guide, drill a 13/64" hole through the side panel. Rivet in place using a PC-000102 rivet from the inside with a PC-000106 back-up washer on the outside. Repeat this step with the left side.



PC-000102 RIVET
2 USED IN THIS STEP

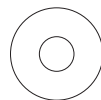

PC-000106 WASHER
2 USED IN THIS STEP

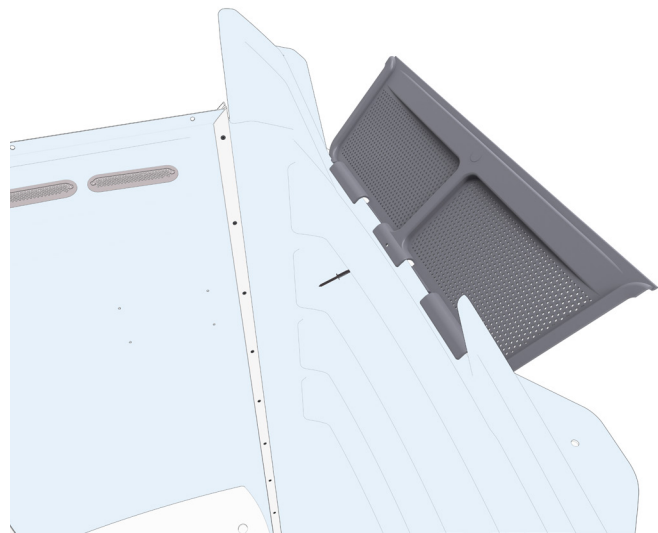

Figure 6

ASSEMBLY INSTRUCTIONS

FLEET™ SERIES
STATIC

STEP 7:

ROOF INSTALLATION

Place the FS1-0061 top extrusion on the top edge of the rear panel so that the miters line up with the left and right extrusions, and that the grooved surface is facing the outside. Place the roof on the top of the unit with the arch in the roof going into the groove in the top of the jamb. Put the rear edge of the roof in the groove in the top rear extrusion. With someone pushing down on the back of the roof, use the holes in the rear extrusion as a drill guide, drill five 13/64" holes into the roof. **MAKE SURE TO ONLY DRILL THROUGH THE ROOF AND NOT THROUGH THE BACK OF THE TOP REAR EXTRUSION.** Rivet the top holes in both the left and right rear extrusions as well as the five holes of the top rear extrusion using (7) PC-000104 rivets. Push down on the front of the roof while using the holes in the jamb as a drill guide, drill five 13/64" holes through the roof. Rivet in place using (5) PC-000104 rivets. Locate the holes in the top of each of the side panels. Push out on the top of the side panel, and using a 13/64" drill bit, drill a hole through the hole in the top of the side, and through the roof. Rivet in place using a PC-000100 rivet on the inside with a PC-000121 washer and a PC-000106 back-up washer on the topside of the roof. Repeat for remaining three holes.



Figure 7
Rear View

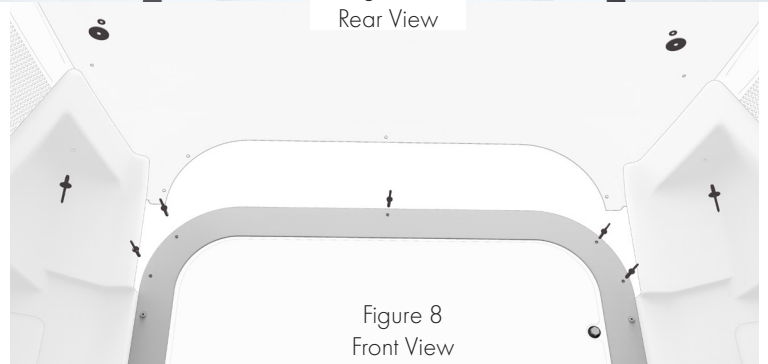
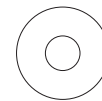
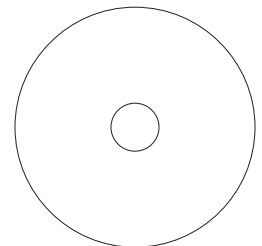

Figure 8
Front View



PC-000106 WASHER
(4) USED IN THIS STEP



PC-000121 WASHER
(4) USED IN THIS STEP

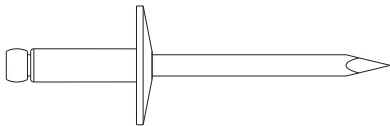

PC-000100 RIVET
(4) USED IN THIS STEP

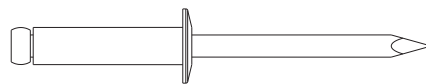

PC-000104 RIVET
(12) USED IN THIS STEP

STEP 8:

VENT STACK INSTALLATION

Force the vent stack up through the hole in the roof then down into the corresponding hole in the tank. Drill a 13/64" hole through the boss in the tank and into the vent stack. Rivet (as shown) using a PC-000117 rivet.

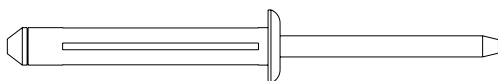

PC-000117 RIVET
(1) USED IN THIS STEP

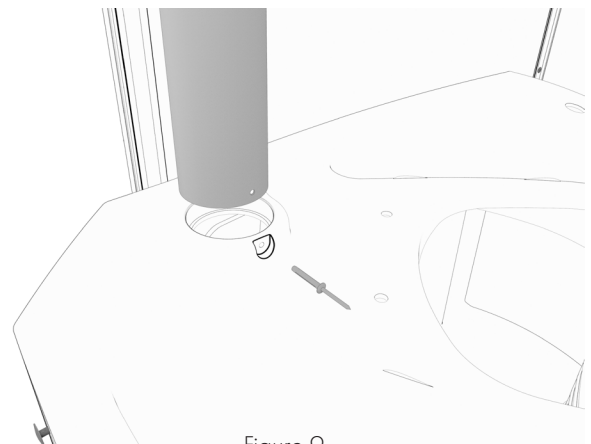

Figure 9

ASSEMBLY INSTRUCTIONS

FLEET™ SERIES
STATIC

STEP 9:

SPRING INSTALLATION

From the front of the door, insert the cable end of the spring assembly into the 1/2" hole in the door. Make sure that the 1/2" boss in the end cap of the spring assembly is pushed through the hole. On the inside of the unit, place barrel end of the cable into the slot of the PC-000181 plastic clip. Using an awl, insert the tip of the awl into the bottom hole of the plastic clip and then pull the clip over with the awl and insert the tip of the awl into the bottom mounting hole in the door jamb. Rotate the clip, lining up the top holes and rivet in place using a PC-000104 rivet. Remove the awl and rivet the bottom hole using the same size rivet.

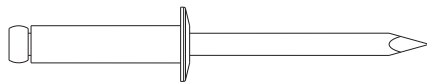

PC-000104 RIVET
(2) USED IN THIS STEP



Figure 10

STEP 10:

OPTIONAL LOCK INSTALLATION

Place the tip of a screwdriver in the lock area of the Door Trim Panel (as shown on the right). Strike the handle end of the screwdriver with a hammer to "knockout" the plastic filling the hole for the lock. Remove the nut from the end of the lock, and insert the lock through the hole of the Door Trim Panel from the outside. Re-insert the nut back on the lock and tighten down. Insert the key and turn the lock to the right and remove the key (this is the locked position which is needed at this point to check the lock for proper installation with the Slide Latch mechanism which is installed in the next step). **NOTE: Turning the key upright is the neutral or normal use position which allows the Slide Latch to move into the "Open/In-Use" position when persons are inside the restroom. Turning the key to the left is the open position and the key can not be removed until either in the "Open/In-Use" or "Locked" position.**

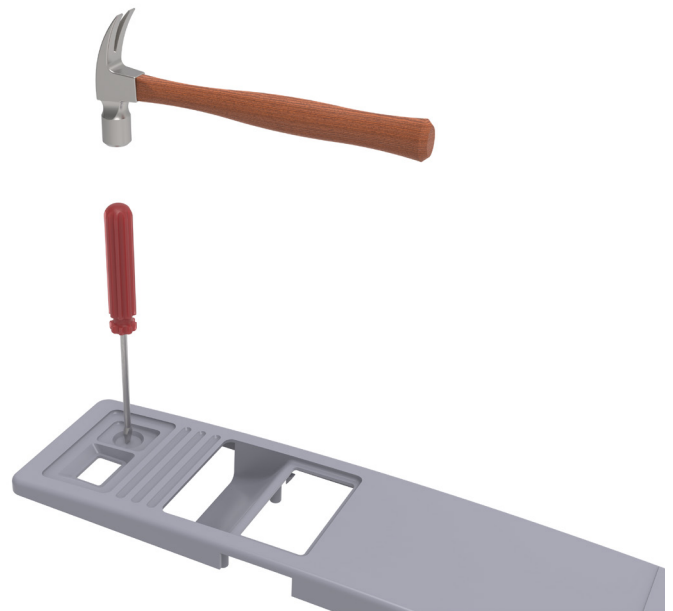

Figure 11

ASSEMBLY INSTRUCTIONS

FLEET™ SERIES
STATIC

STEP 11:

DOOR PANEL / SLIDE LATCH INSTALLATION

Snap the Unisex Indicator Plate into the back of the Door Trim Panel. Place the Door Trim Panel into the recess in the front of the door. While holding the Door Trim Panel in position, place the Slide Latch and Slide Latch Cover Plate on the inside of the door and line up the holes of the Slide Latch Cover Plate, the Door, and the Door Trim Panel. Insert (4) PC-000158 screws and tighten. **NOTE: These screws should be tightened to the point where they will interfere with the sliding action of the Slide Latch and then backed off slightly, leaving enough friction to prevent the Slide Latch from sliding into the "In-Use/Open" position when the door shuts. The U Shaped handle prevents persons from inadvertently moving the slide latch to the "In-Use" position when exiting the restroom.** Insert the flip "Male-Female" Indicator Plate into the slot on the top edge of the Door Trim Panel (above where the Unisex Indicator Plate is located). Insert (2) PC-000147 screws into the holes toward the hinged side of the door, line up with the holes in the Door Trim Panel, and tighten. If the optional lock is installed, unlock the lock by inserting the key into the lock and turning to the left and back to the upright position which is the neutral or normal use position and remove the key (this allows the Slide Latch to move into the "Open/In-Use" position when persons are inside the restroom). Turn the key to the right and remove the key for the locked position. Turning the key to the left indicates the open position and the key can not be removed until either in the "Open/In-Use" or "Locked" position. **IMPORTANT: The punched 1/4" hole in the center of the Slide Latch where the "In-Use/Open" stamp is imprinted complies with code enabling the door to be unlocked from outside the restroom in the event of distress and a person inside were unable to unlock the door. A POINTED OBJECT INSERTED INTO THE HOLE AND MOVING THE SLIDE LATCH TO THE LEFT WILL ALLOW THE DOOR TO BE OPENED PROVIDING THE DOOR HAS NOT BEEN LOCKED WITH THE KEY.**

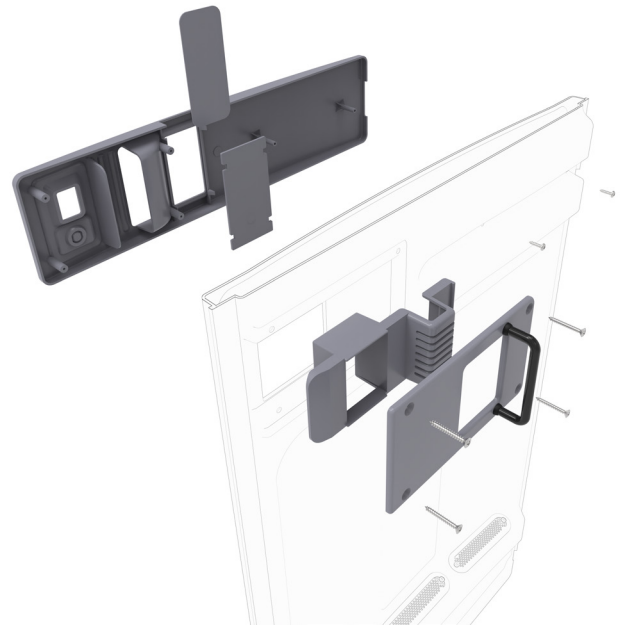
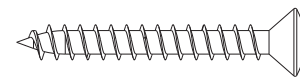
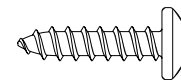

Figure 12



PC-000158 SCREW
(4) USED IN THIS STEP



PC-000147 SCREW
(2) USED IN THIS STEP

STEP 12:

MIRROR INSTALLATION

Peel the protective cover from the front of the mirror. Place the mirror in the recess in the door, and fasten in place using the plastic push in fasteners provided.

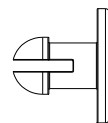

PC-000367 - PUSH-IN FASTENER
(4) USED IN THIS STEP



Figure 13

ASSEMBLY INSTRUCTIONS

FLEET™ SERIES
STATIC

STEP 13:

TOILET SEAT INSTALLATION

Place the toilet seat on the top of the tank. Line up the holes in the hinge of the seat with the holes in the top of the tank. Insert the seat bolts through the hinges of the seat and through the seat base. Lift open the seat base, thread the plastic seat nuts on the ends of the bolts and tighten.

STEP 14:

OPTIONAL URINAL INSTALLATION

Insert the drain spigot into the hole in the tank (as shown). Make sure that the top of the urinal is level and drill two 13/64" holes in the center of each of the recess' through the top of the urinal and through the side panel. Rivet in place using (2) PC-000101 rivets from the inside of the unit with (2) PC-000106 back-up washers on the outside.

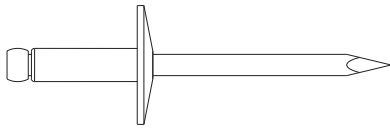

PC-000100 RIVET
(2) USED IN THIS STEP

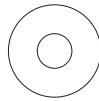

PC-000106 WASHER
(2) USED IN THIS STEP

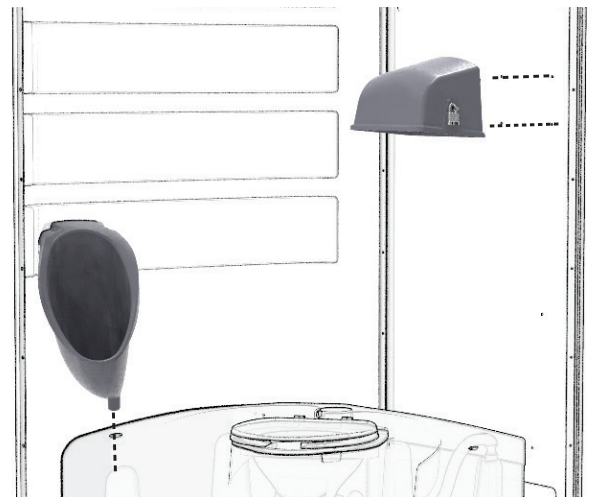
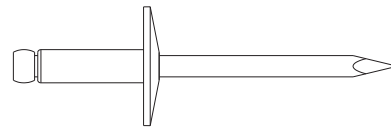

Figure 14

STEP 15:

TOILET PAPER DISPENSER

There are four dimples in the rear panel for the Toilet Paper Dispenser location. From the outside, drill four 13/64" holes through the rear panel. Line up the holes in the rear panel with the holes in the back of the dispenser, and rivet in place from the outside using (4) PC-000100 rivets with (4) PC-000106 back-up washers on the inside.



PC-000100 RIVET
(4) USED IN THIS STEP

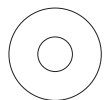

PC-000106 WASHER
(4) USED IN THIS STEP

PARTS DIAGRAM

FLEET™ SERIES
STATIC

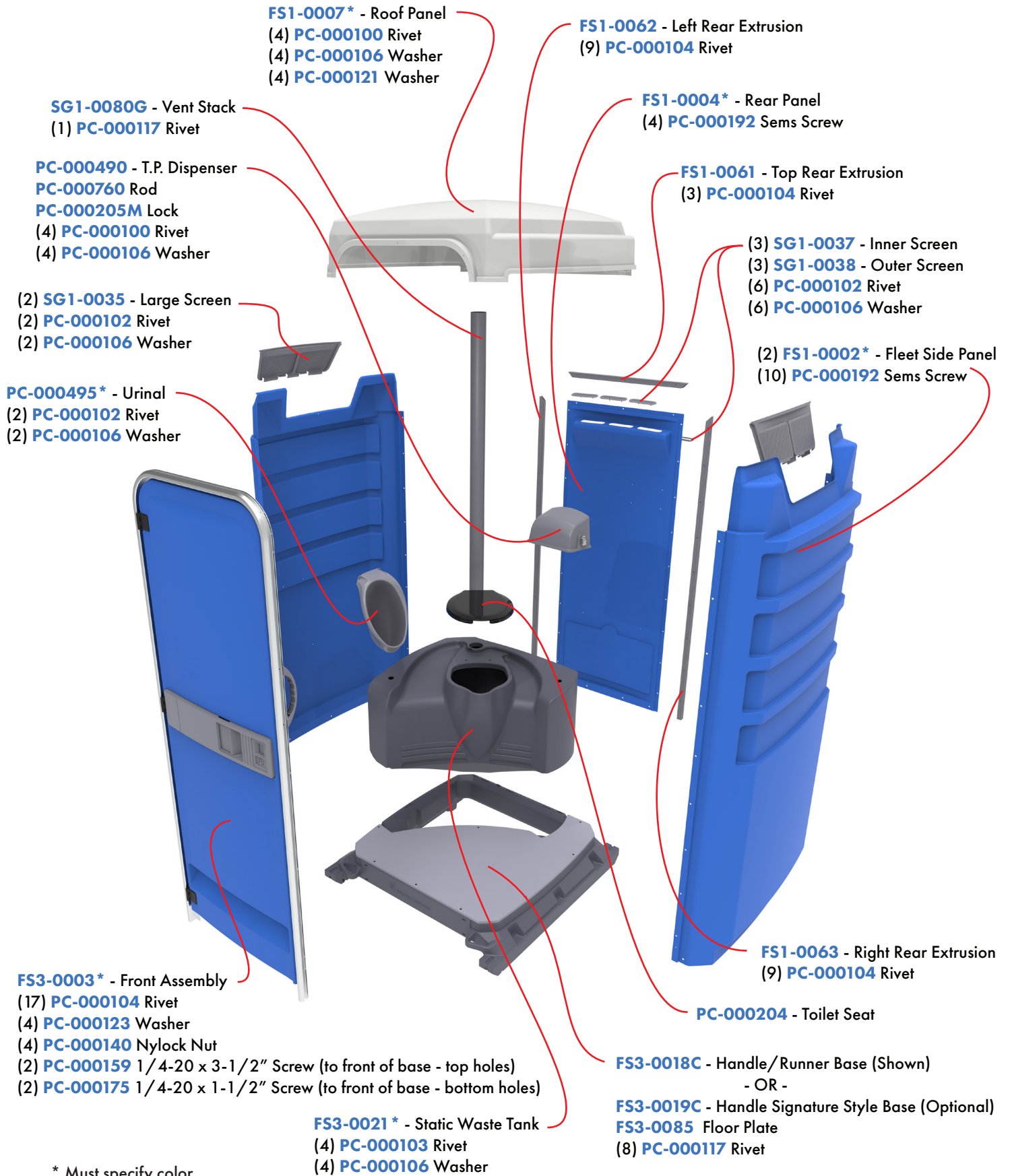

PARTS DIAGRAM

Fleet Front Assembly Parts

FLEET™ SERIES
STATIC

FS3-0003* - Fleet Front Assembly
(Contains the following parts)
-FS1-0005*C - Door Complete
-FS3-0060 - Door Jamb
-PC-000116 - Rivets (Door Hinges to Jamb)
-PC-100787 - Serial ID Plate
-PC-000108 - Rivets (Serial ID Plate)
(all other parts must be ordered separately)

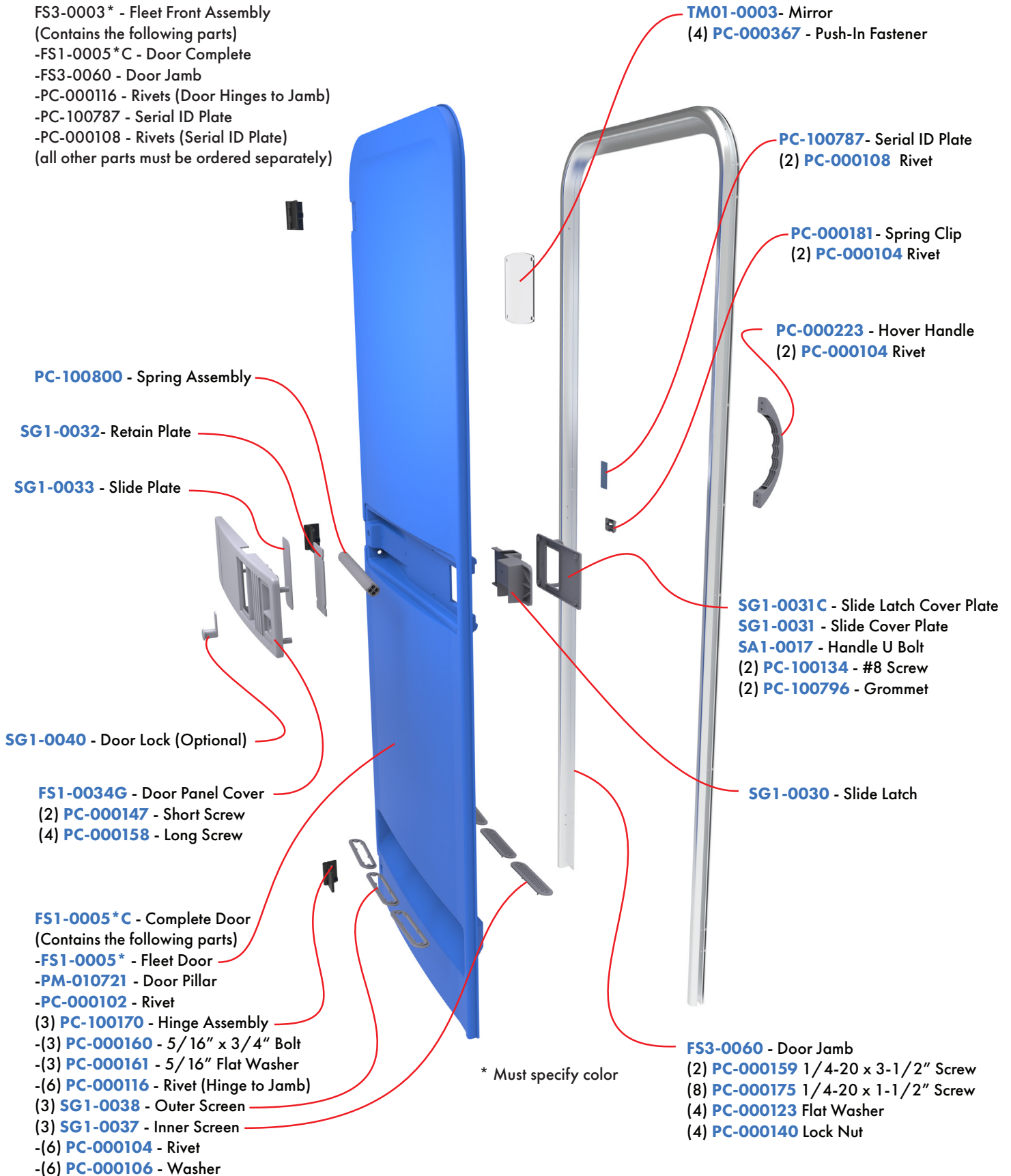

OPTIONAL ACCESSORIES, SUPPLIES AND CHEMICALS

FLEET™ SERIES
STATIC



LIQUID HAND SANITIZER
PSD 1-1000

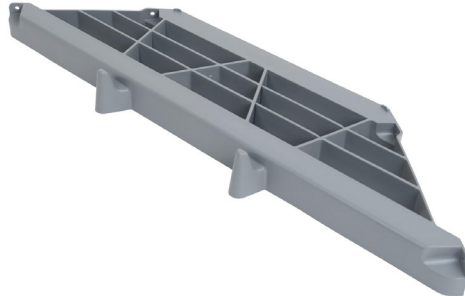

FLEET SHELF
SU3-0001 F



DEODORIZING
PACKAGES

CLEANING AND MAINTENANCE

Use a mild soap to clean all surfaces and component parts.

Minor scratches and abrasions can be lightly sanded or scrubbed with a mild abrasive cleaner (such as "Soft Scrub") that contains calcium carbonate, hypochlorate bleach, and detergents. Be sure to follow the cleaning product directions since these ingredients may cause hazardous gases when mixed with other chemicals. Rinse the cleaned areas and buff with a conventional wax.

Some light scratches may also be hidden by using an industrial hot air gun.

For a source of cleaning, deodorizing and paper products contact:

PRO'S CHOICE
2500 GASPAR AVE.
WHITING, IN 46394-2175
800-292-1305
www.polyjohn.com/supplies/pros-choice.html

We highly recommend membership in the Portable Sanitation Association International (PSAI); the worldwide authority on portable sanitation services. The PSAI, "Portable Sanitation Industry Certification Program" manual contains a wealth of information on standards and service procedures. For more information contact the PSAI:

PORTABLE SANITATION ASSOCIATION INTERNATIONAL (PSAI)
7800 METRO PARKWAY, SUITE 104
BLOOMINGTON, MINNESOTA 55425 USA
800-822-3020 / 612-854-8300 FAX 612-854-7560
www.psa.org

INSTRUCTIONS FOR USE

FLEET™ SERIES
STATIC

Follow these instructions for setting up your portable restroom:

Step 1 – Charge the tank – this refers to filling the waste tank with approximately 5 gallons (19 liters) of fresh water. The tank must be charged with fresh water first. Charging the tank will allow deodorizers (once added) to be activated.

Step 2 – Add deodorizers to waste tank – This is a critical step. These deodorizers help to break down the waste and relieve the smell. Deodorizers added to the waste tank will dissolve in the water charge. These deodorizers are most always dyed blue. In the portable toilet industry the deodorizers are often referred to as just that – blue. Deodorizers come in a variety of forms: pucks, packets, and liquid. They also come in a variety of scents. To find out more information on deodorizers PolyJohn offers visit <https://www.polyjohn.com/supplies/pros-choice.html> or call 800-292-1305 to speak to a representative.

- **Note:** Amount of deodorizer used depends on what form you purchase and its use.

Step 3 – To get rid of the waste in your tank you must call your local portable restroom operator to vacuum out the waste, or if tank is equipped with dump valve, by bringing it to a local RV dump site or waste treatment plant.

This concludes standard restroom set up. Your restroom is ready for use. For restrooms with options such as sinks & flushable tanks follow the below instructions accordingly:

Restroom with Sink – The gray water from the sinks is designed to empty into the waste tank. Water capacity of sinks varies. Visit the PolyJohn website at <https://www.polyjohn.com/products/sinks.html> to find your sink. Under the specifications tab on each product page it will tell you the sink capacity.

- To open the PJN3 and Fleet sink either insert a small tool in the hole in the front of the sink where the sink bowl & tank meet, or press firmly in this area. This will release the metal latch to lift the lid. The sink can be filled from that opening.
- For the Single User Wash Station there is a port hole to fill with fresh water.
- To completely empty your sink there is a drain port at the bottom.
- For pictures, videos, and manuals for each sink visit <https://www.polyjohn.com/products/sinks.html> and find your sink.

Fresh Flushing Tank Option – Fresh flushing tank options always require a sink. The flushing capability of the bowl draws fresh water from the sink to flush. Follow the instructions above to find the water capacity of your sink.

Soap Dispenser – PolyJohn's own designed liquid soap dispenser can be filled with any non-foaming liquid soap. Just twist the lid and fill with your liquid soap.

Foam Dispenser – PolyJohn offers a foaming hand sanitizer dispenser. Specially designed hand sanitizer refill packets are required for this dispenser. You can find them by visiting <https://www.polyjohn.com/supplies/pros-choice.html>.

Paper towel Dispenser – PolyJohn's paper towel dispenser can be filled with either folding towels, or rolls. The recommended towels are Tork Universal Hand Towel Roll (Item# RK350A) or Georgia-Pacific Envision® Singlefold Towels (item # GP-23504).

Toilet Paper Dispenser – PolyJohn offers a 2 roll dispenser, or a 3 roll dispenser. The dispenser rod is designed for small core toilet paper rolls, but can work with standard rolls if desired. PolyJohn offers its own line of toilet paper. Please visit <https://www.polyjohn.com/pros-choice-tp> for more information.

For more information including pictures, videos, and documents for each product please visit www.polyjohn.com. You can also call 800-292-1305 and talk to one of our customer service representatives.

FREQUENTLY ASKED QUESTIONS

FLEET™ SERIES
STATIC

Toilets and Restrooms

Q: Can I use a toilet unit on my own, or do I need a professional?

A: It is illegal to dispose of human waste in an improper way. You can purchase a portable toilet for your own personal use, but you will need to hire a professional portable toilet operator to empty and dispose of the waste when needed.

Q: Can any toilet unit have a sink added to the inside?

A: Not every unit can house an interior sink. The Comfort XL and We'll Care units do not have interior sinks. The Comfort XLT, PJN3, PJP3 and Fleet do have interior sinks. All Fresh Flush units require a sink to operate, but static and recirculating flush units can add a sink.

Q: How do I initially set up a portable toilet for use?

A: For each new use of an emptied tank, it needs to be charged with 5 gallons of water and a chemical often referred to as "blue" in the industry. It contains dyes and enzymes designed to break down waste.

Q: Can I replace parts on my toilet?

A: Absolutely. We offer all our parts as replacements. Just call into PolyJohn or contact your local rep to place an order.

Q: My toilet has a dump valve, can I use that to empty the waste tank?

A: You can use the dump valve to empty the tank, but it needs to be done at an RV dump station that has the proper equipment and treatment on site. You can also hire a local portable toilet operator to empty the waste tank.

Q: In my recirculating unit where does the water come that flushes the toilet bowl?

A: A recirculating unit takes the water that is inside the tank and uses it to flush the toilet bowl. Yes, it is the used water inside the tank. Do not be worried about this. There are two separate filters that filter out any solid substance before it comes to the bowl. And this water has been mixed with the powerful chemicals that break down waste inside the tank. This saves fresh water usage while still getting the benefits of flushing.

Q: How does the fresh water flush toilets work?

A: Unlike the recirculating toilets, the fresh water models require a sink. The bowl flushing mechanism draws fresh water from the sink to flush. The sink also uses the fresh water for hand washing and the gray water drains into the toilet tank.

Q: My screen broke, how do I replace it?

A: The screens can be removed and replaced by drilling out the rivets, sliding the screen out, sliding the new one in and re-riveting the screens in place.

Q: You don't have the old style urinal anymore, so will a new style work? If so, what do I need to do to modify my unit so the new urinal will fit?

A: The new PolyJohn Urinal has been completely redesigned. The new design has been proven to be the best shape and form to keep splash-back to a minimum. The side walls are much higher and there is no lip on the inside. This will help keep the urinal clean. The entire urinal has smooth surfaces as well to aid in cleaning. The new urinal can also hold 5 pounds of salt for colder climates. To help your customers who might need something to shoot for. To install the new urinal on old tanks, you will need 4 - PC-000102 Rivets, 4 - PC-000106 Washers, and 1 PC-000557 Cap.

Prop 65

PolyJohn Corporation would like to inform any customers or end users that some products may contain chemicals listed in California's Safe Drinking Water & Toxic Enforcement Act of 1986. Commonly referred to as Proposition 65, this Act establishes a list of chemicals known by the State of California to present a risk of cancer, birth defects, or other reproductive harm.

Chemical exposure typically occurs through inhalation, ingestion, or adsorption. PolyJohn products are not intended to be used in these methods. PolyJohn Corporation cannot foresee all uses of their products (both intended and unintended uses) and as a result has opted to provide a general warning of known chemical presence.

The Proposition 65 chemical list can be found at <http://www.P65Warnings.ca.gov>

The following warnings are labels placed on affected products. If these labels are not present then they do not apply to that product.



WARNING: This product can expose you to chemicals including 4-Vinylcyclohexene which is known to the State of California to cause cancer and birth defects or other reproductive harm. For more information go to www.P65Warnings.ca.gov.

4-Vinylcyclohexene label above to be used any product made with Bayblend T85



WARNING: This product can expose you to chemicals including titanium dioxide, which is known to the State of California to cause cancer. For more information go to www.P65Warnings.ca.gov.

Conflict Minerals Compliance Statement

Section 1502 of the Dodd-Frank Wall Street Reform and Consumer Protection Act, and the Securities and Exchange Commission Rules adopted in connection therewith, require certain corporations to report the use of "Conflict Minerals" in the manufacture of their products. Generally, Conflict Minerals collectively refers to cassiterite, columbite-tantalite, gold, wolframite, or their derivatives, including tantalum, tin and tungsten, which originate from the Democratic Republic of the Congo or specified adjoining countries (referred to herein as "Covered Countries").

While we, as a privately held corporation, are not subject to the Conflict Minerals rules and reporting requirements, we understand that our customers may be, and we are committed to helping our customers comply with their reporting requirements. In order to determine if our manufactured products contain Conflict Minerals, we have asked our relevant suppliers, as of September 1, 2020, to ascertain their use of any Conflict Minerals in the materials they supply to us. Their responses demonstrate that our relevant suppliers (i) do not use Conflict Minerals in the materials they supply to us, (ii) have no reason to believe the Conflict Minerals they use may have originated in the Covered Countries, and/or (iii) reasonably believe that the Conflict Minerals they use are from recycled or scrap sources. Consequently, we can in turn represent that, to the best of our knowledge, our manufactured products either do not contain Conflict Minerals, or to the extent they may, such products are "DRC conflict free" as defined by paragraph (e)(4) of Section 1502.

We will continue to work with our key suppliers to ensure that we are able to identify the use of Conflict Minerals in our supply chain, and the representations made in this compliance statement remain accurate. To that end, we reserve the right to amend this statement at any time based on subsequent developments or information.

Should you have any questions or concerns regarding this statement, please do not hesitate to contact us.

RESTROOMS AND TOILETS

POLYJOHN PORTABLE RESTROOMS LIMITED 3 YEAR PRODUCT WARRANTY

PolyJohn Enterprises Corp. warrants the major plastic parts of its portable restrooms (plastic front, wall panels, roof, and tank) against any breakage or other problems that prevent the PolyJohn portable toilet from functioning in accordance with usual practices used in the portable toilet industry and in their intended manner. This warranty covers any damages in material or workmanship for a total period of 3 years (36 months). This warranty extends only to the original purchaser of the PolyJohn portable restroom. Proof of purchase, serial numbers, and photos will be required.

SINKS, TANKS, TRAILERS AND SANISTANDS

PolyJohn Enterprises warrants our sinks, tanks, trailers and sanistands from the date of purchase. Any misuse or abuse of our products or failure to properly follow recommended procedures shall void this warranty. The warranty is a 1 year limited warranty and a 90 day limited warranty for components thereof.

What is Not Covered By Warranty

This warranty does not cover damage or failure contributed to or caused by: Not following PolyJohn assembly procedures, unauthorized modification, acts of God, mishandling, misuse, use of incompatible solvents or other damaging chemicals, vandalism or accident. In no event shall PolyJohn be liable for labor costs or for incidental or consequential damages.

For full details on PolyJohn's warranty policy, and to view instructions for submitting a claim please visit <https://www.polyjohn.com/warranty/>.

Warranty Disclaimer

PolyJohn's terms of sale are FOB (Free on Board Shipping Point). Meaning buyer takes on responsibility once it leaves PolyJohn's shipping dock. The carrier is wholly responsible for any damage incurred during transit. Important notice: All concealed/non-notated damages must be reported within 5 business days of delivery (1st day is the day of delivery) as per the National Motor Freight Classification (NMFC) – Rule 300100 - for a damaged claim to be filed. Reporting after this time will void a claim.

In order to prevent warranty disputes follow these steps immediately when receiving your products:

Inspect the shipment immediately and insist that visible damages be indicated on your copy of the freight bill. If they are not noted on the freight bill it is very likely a claim will be denied.

Open the shipment if necessary, and inspect for any concealed damages.

If there are any damages that you cannot operate with you may refuse shipment. After you do this contact us immediately

Filing Process for Warranty

PolyJohn reserves the right to request inspection of products for verification of defect, which may include returning some or all of the parts with shipping paid for by the purchaser. Once the items have been returned, inspected, and PolyJohn is found at fault shipping costs will be reimbursed. You may contact PolyJohn to arrange for return shipping if desired.

To file your warranty claim follow these steps:

1. Go to [polyjohn.com/warranty/](https://www.polyjohn.com/warranty/)
2. Fill out necessary contact information
3. Fill in invoice number, date of purchase, product, and product serial numbers.
4. Upload an images of affected products
5. Submit and someone will be in contact with you as soon as possible.

OUR MISSION STATEMENT

FLEET™ SERIES
STATIC

“PolyJohn is a family owned, state of the art, plastics manufacturing company dedicated to providing its employees with a work environment committed to excellence, and its customers with innovative products, services and technology that meet or exceed their requirements.”

THANK YOU FOR PURCHASING POLYJOHN PRODUCTS!



POLYJOHN®
there when you need us

POLYJOHN USA
+1 800-292-1305
Whiting, Indiana
www.polyjohn.com

POLYJOHN INTERNATIONAL
UNITED KINGDOM
+44 (0) 1937-583333
Yorkshire, England
www.polyjohn.co.uk

POLYJOHN CANADA
+1 800-465-9590
Oro Medonte, Ontario
www.polyjohn.ca
www.fr.polyjohn.ca

POLYJOHN LATIN AMERICA
+01 800-953-1307
Chihuahua, Mexico
www.polyjohn.mx

POLYJOHN AUSTRALIA
+61 7 3277 5727
Brisbane, Australia
www.totalsanitationsolutions.com.au

POLYJOHN SOUTHERN AFRICA
+27 (011) 615-3804
Johannesburg, South Africa
www.polyjohn.co.za

POLYJOHN NEW ZEALAND
+64 (0)22 387 7142
Auckland, New Zealand
www.polyjohn.co.nz

POLYJOHN SOUTH AMERICA
+57 318 696 7744
Bogotá, Colombia
www.polyjohn.com

POLYJOHN INTERNATIONAL
CZECH REPUBLIC
+420 608 876 983
Karlovy Vary, Czech Republic
www.polyjohn.eu